

VICTORIA B 28

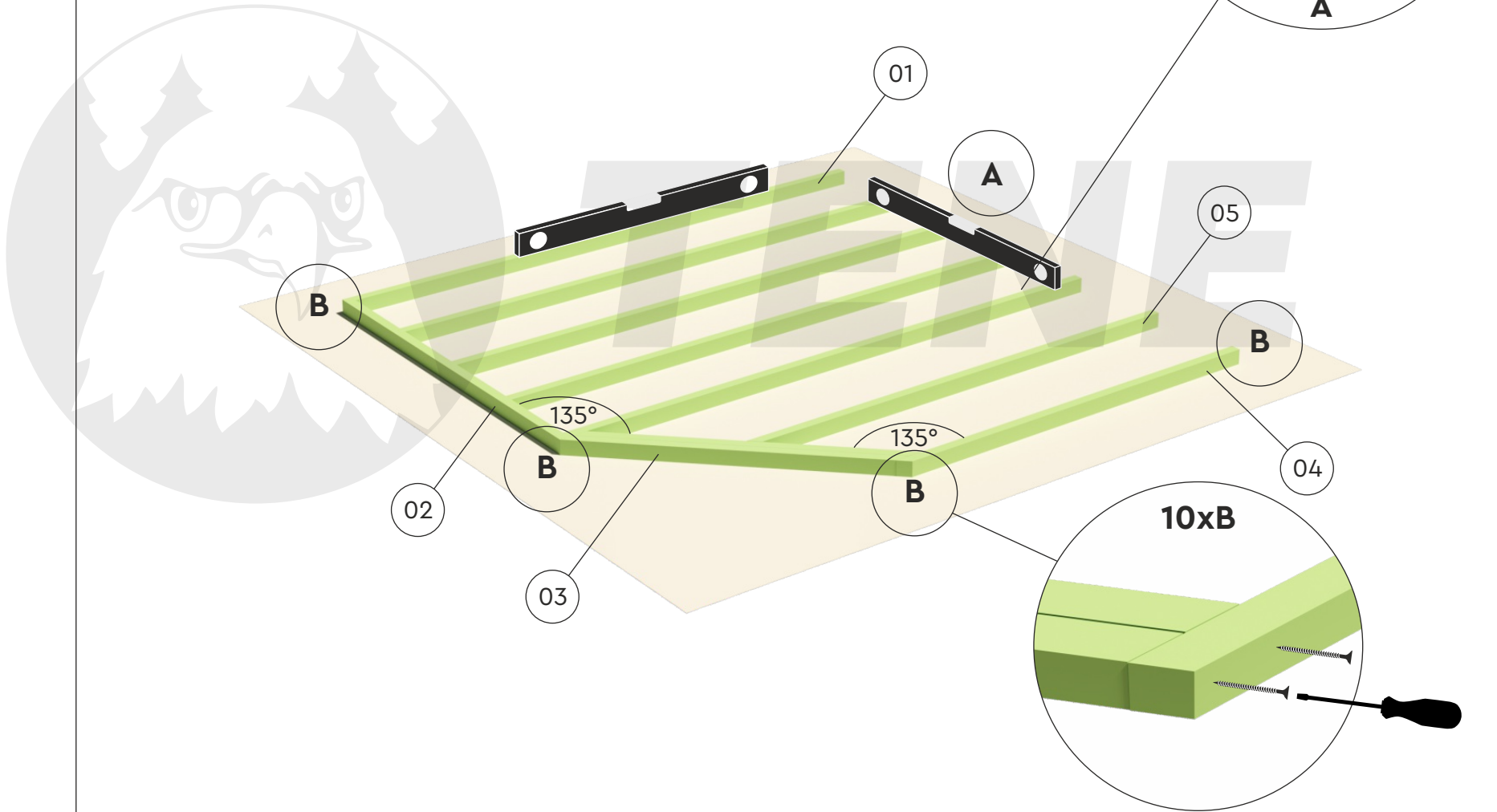

VICTORIA B 28

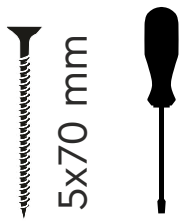
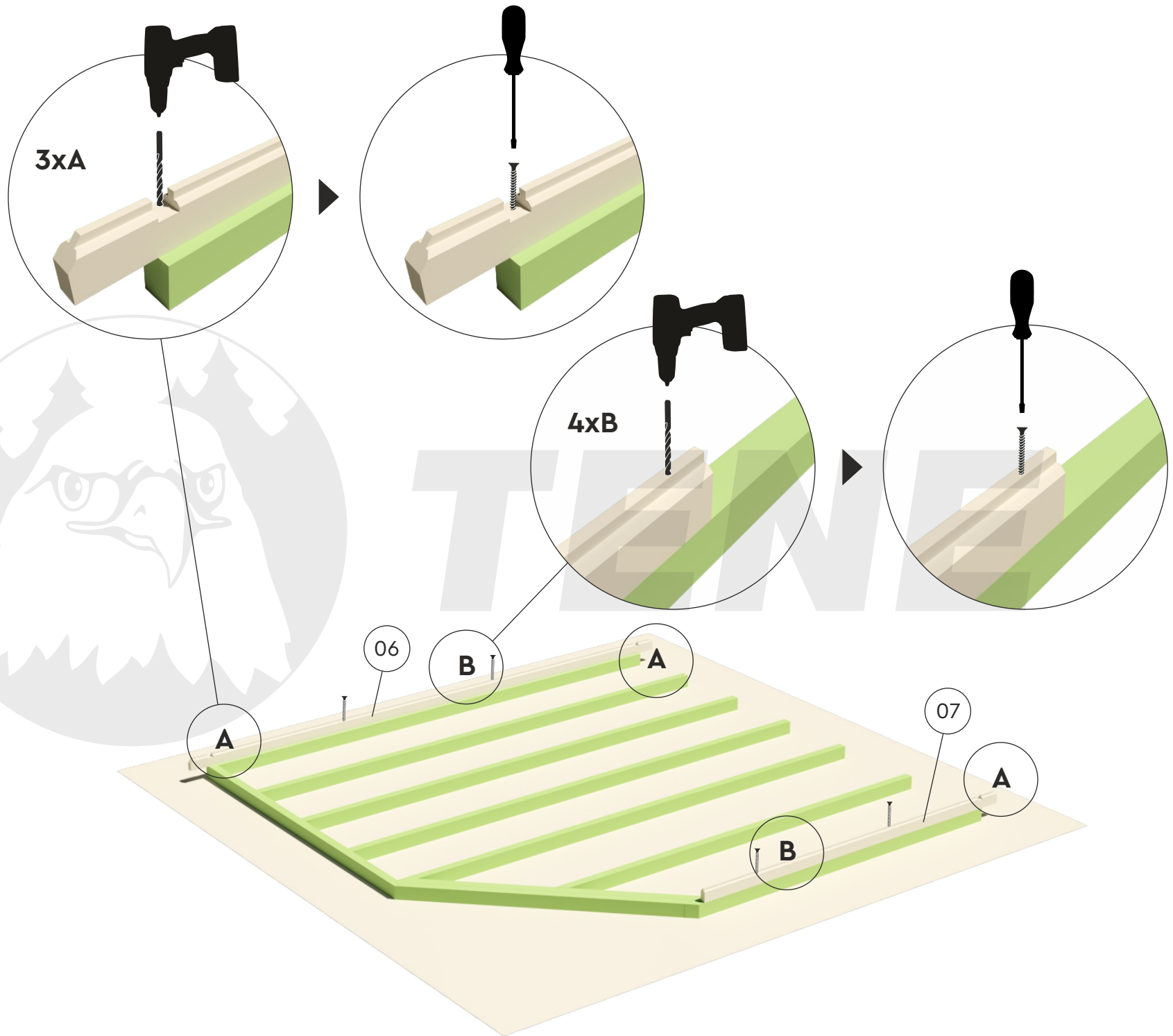

VICTORIA B 28

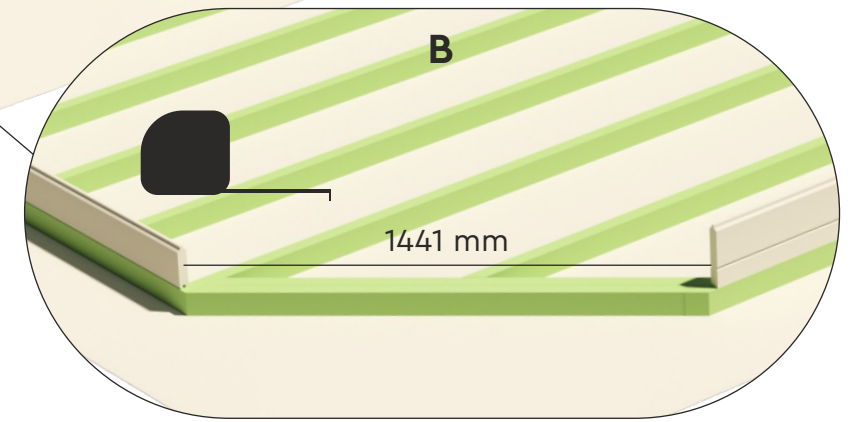
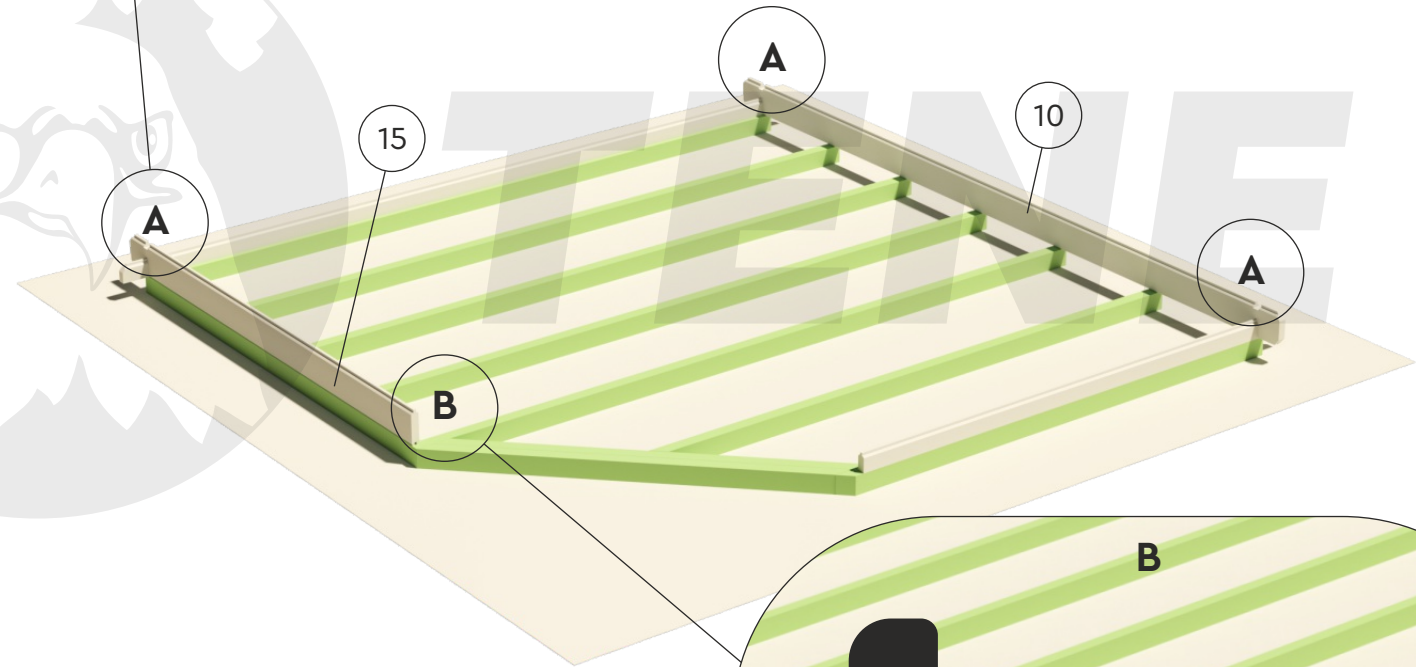
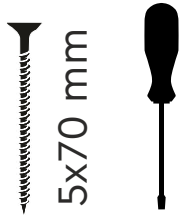
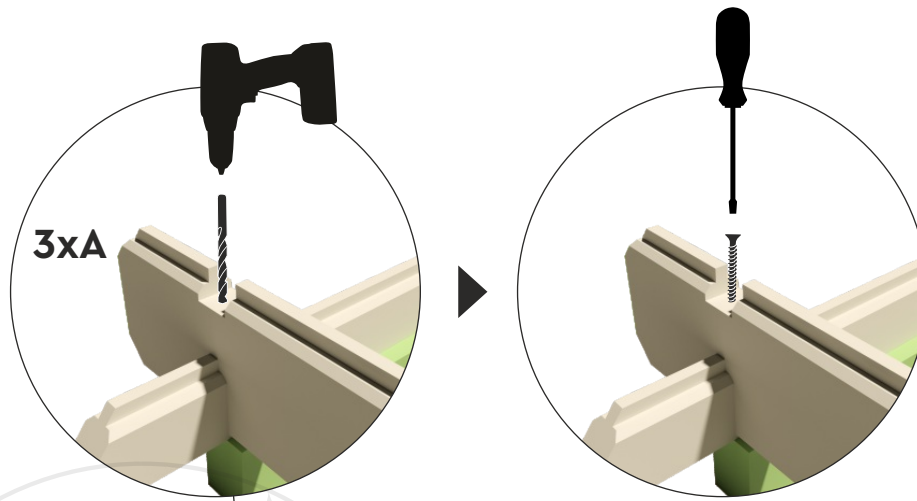

VICTORIA B 28

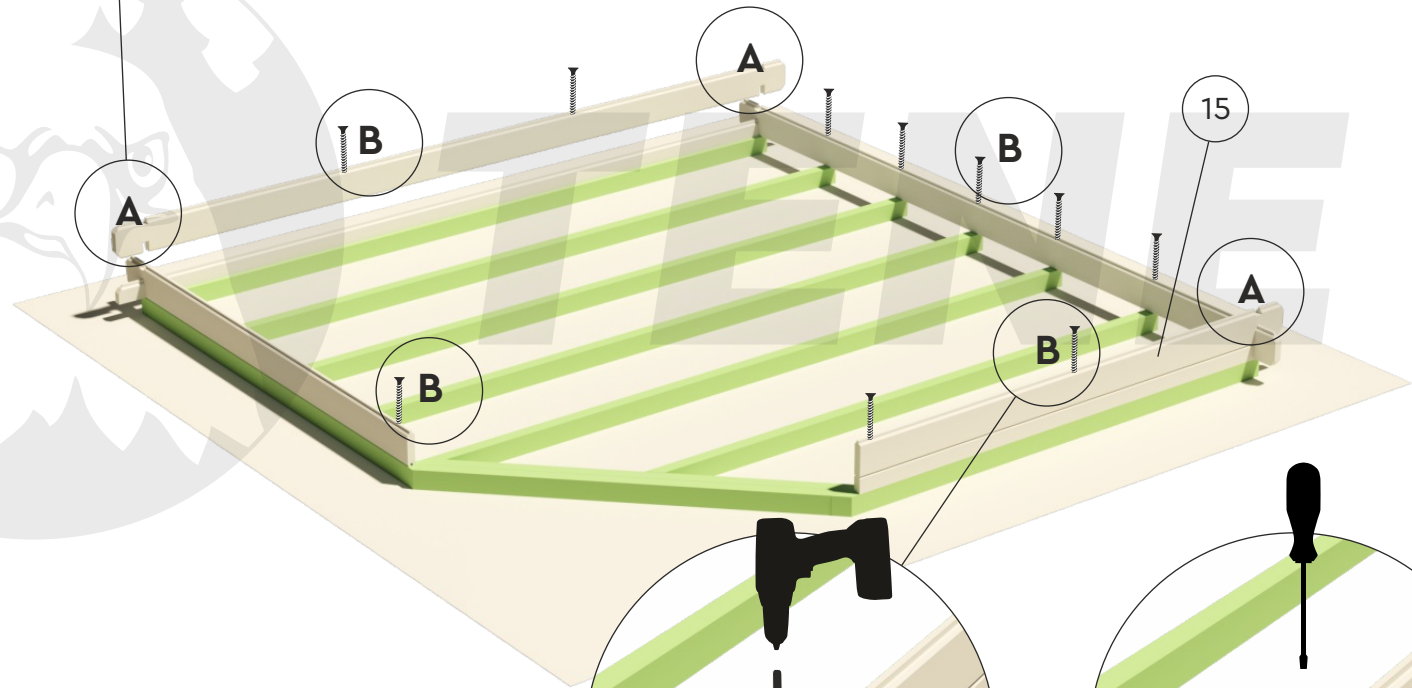
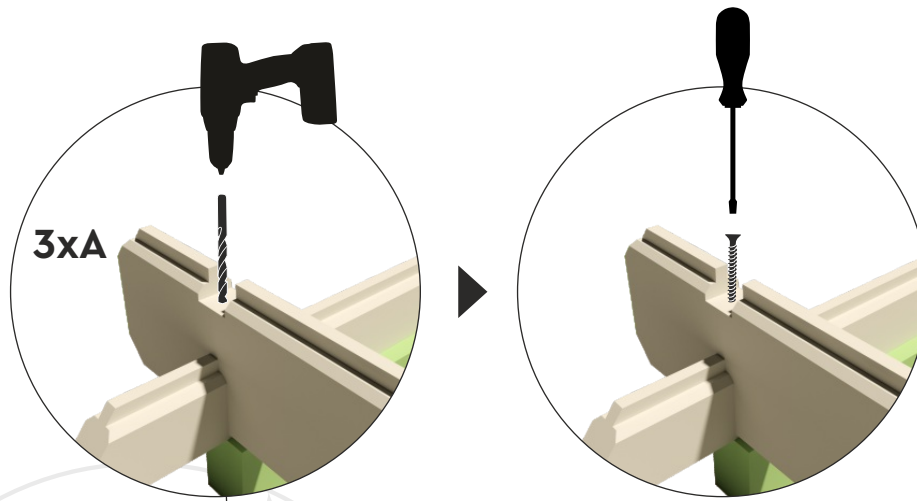

Ø 5 mm

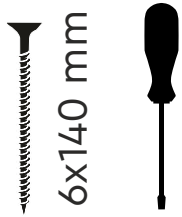

6x140 mm

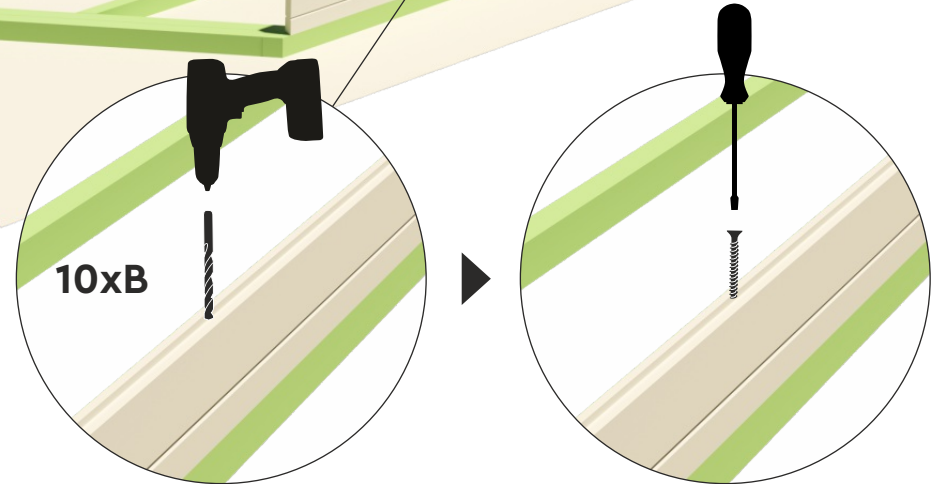

VICTORIA B 28

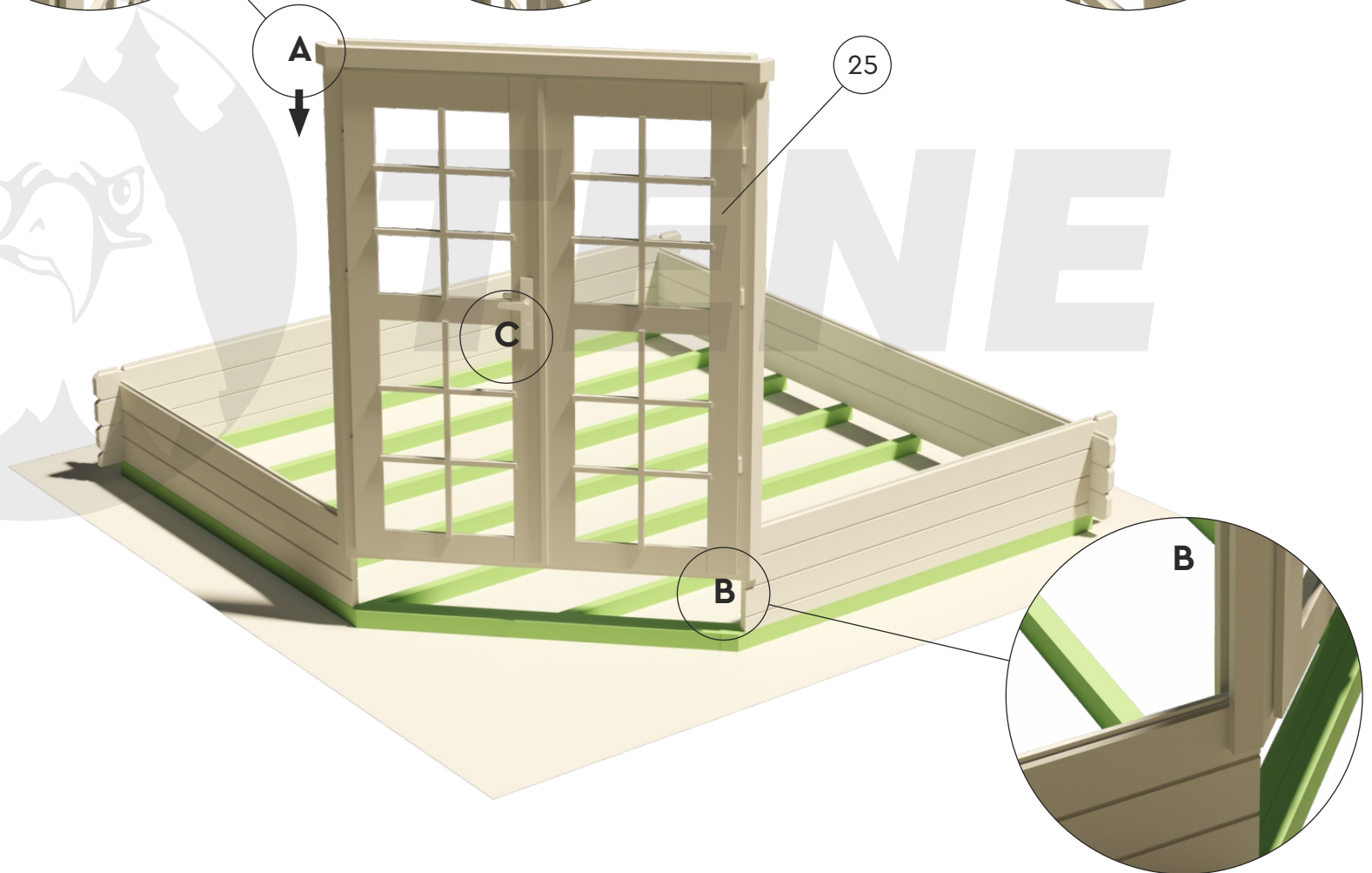
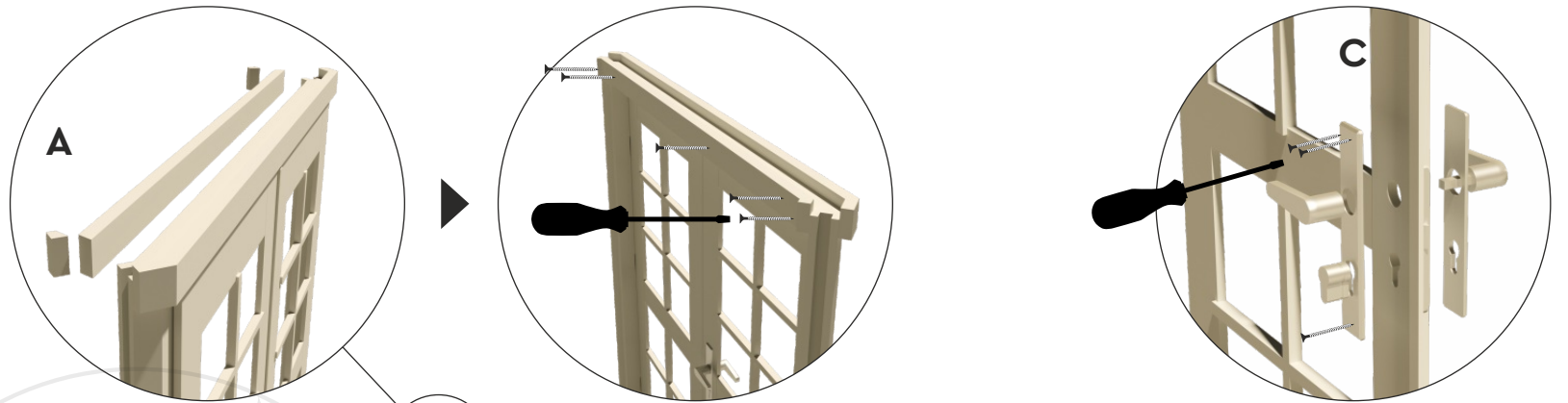

4x40 mm



VICTORIA B 28

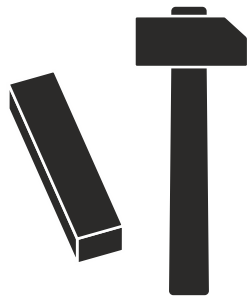
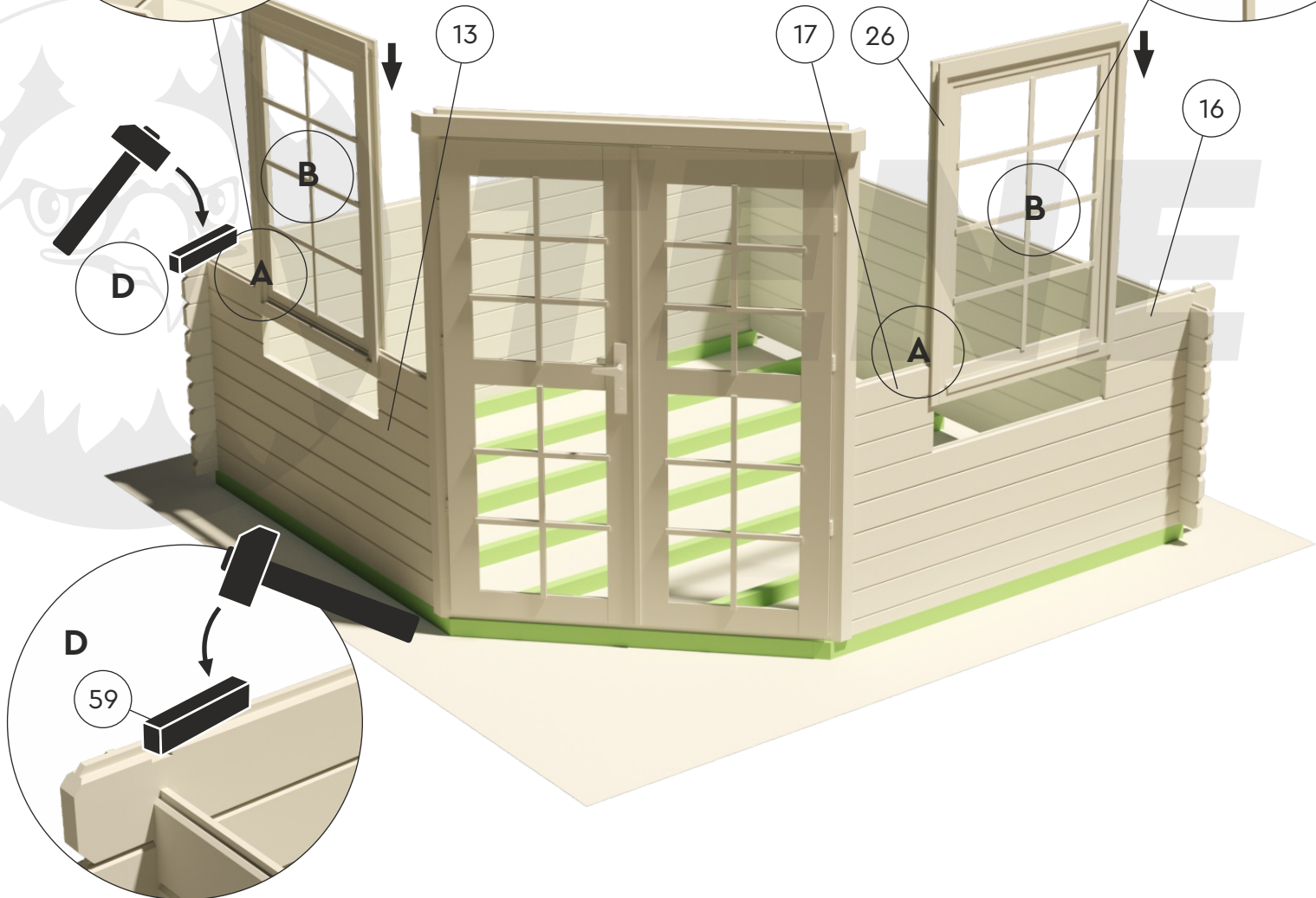
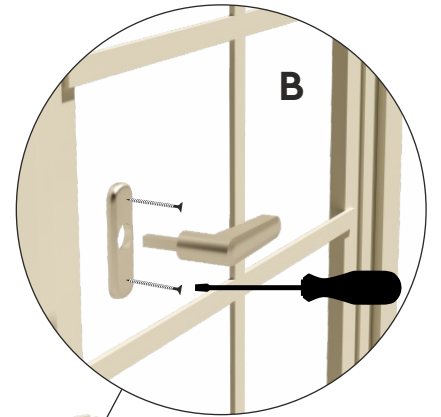
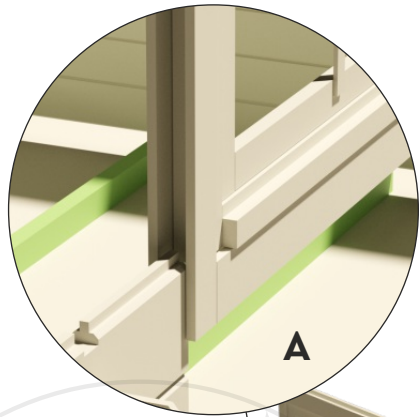

VICTORIA B 28

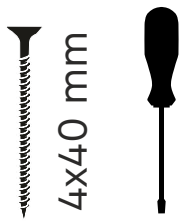
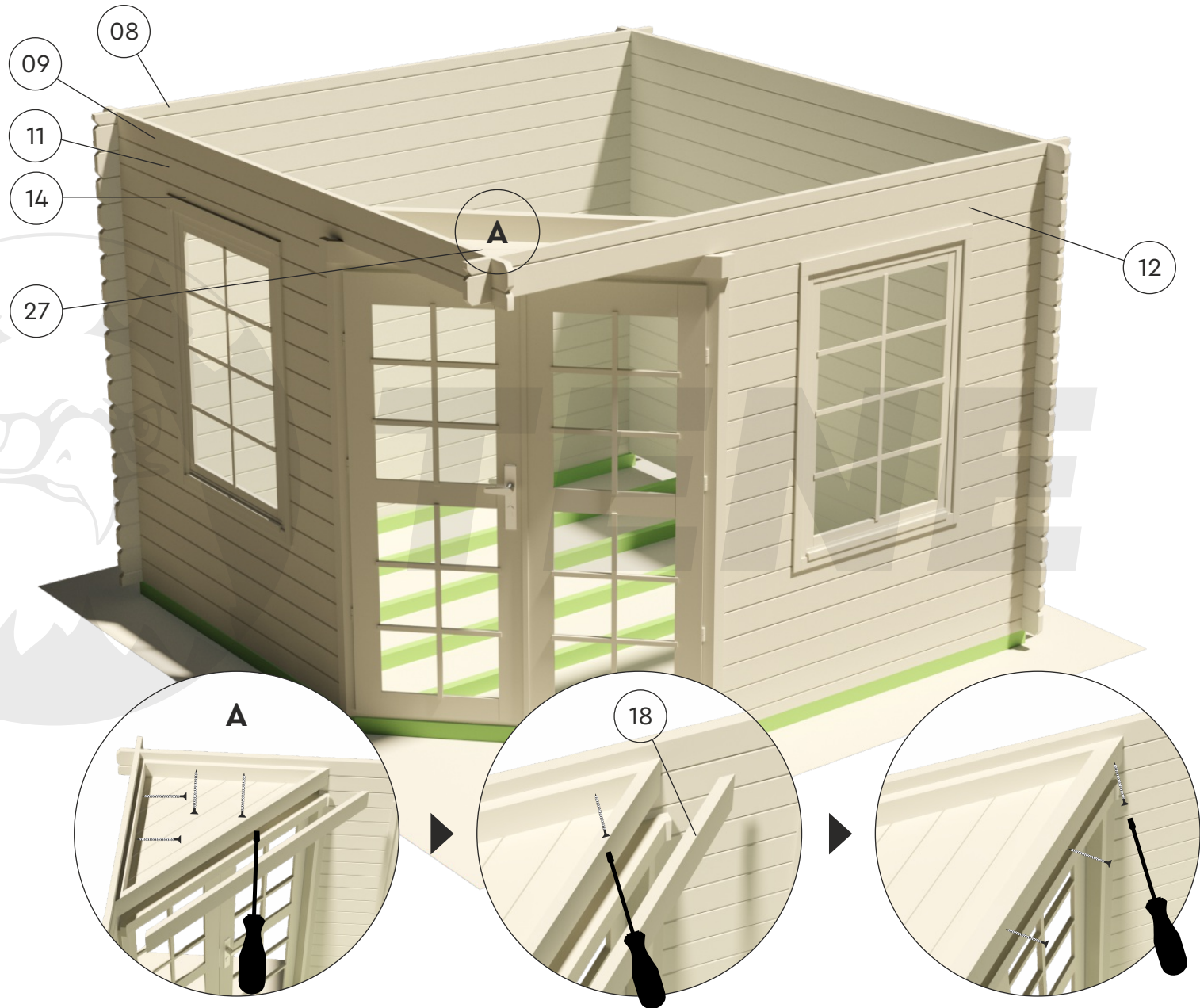

VICTORIA B 28

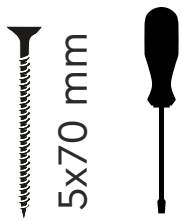
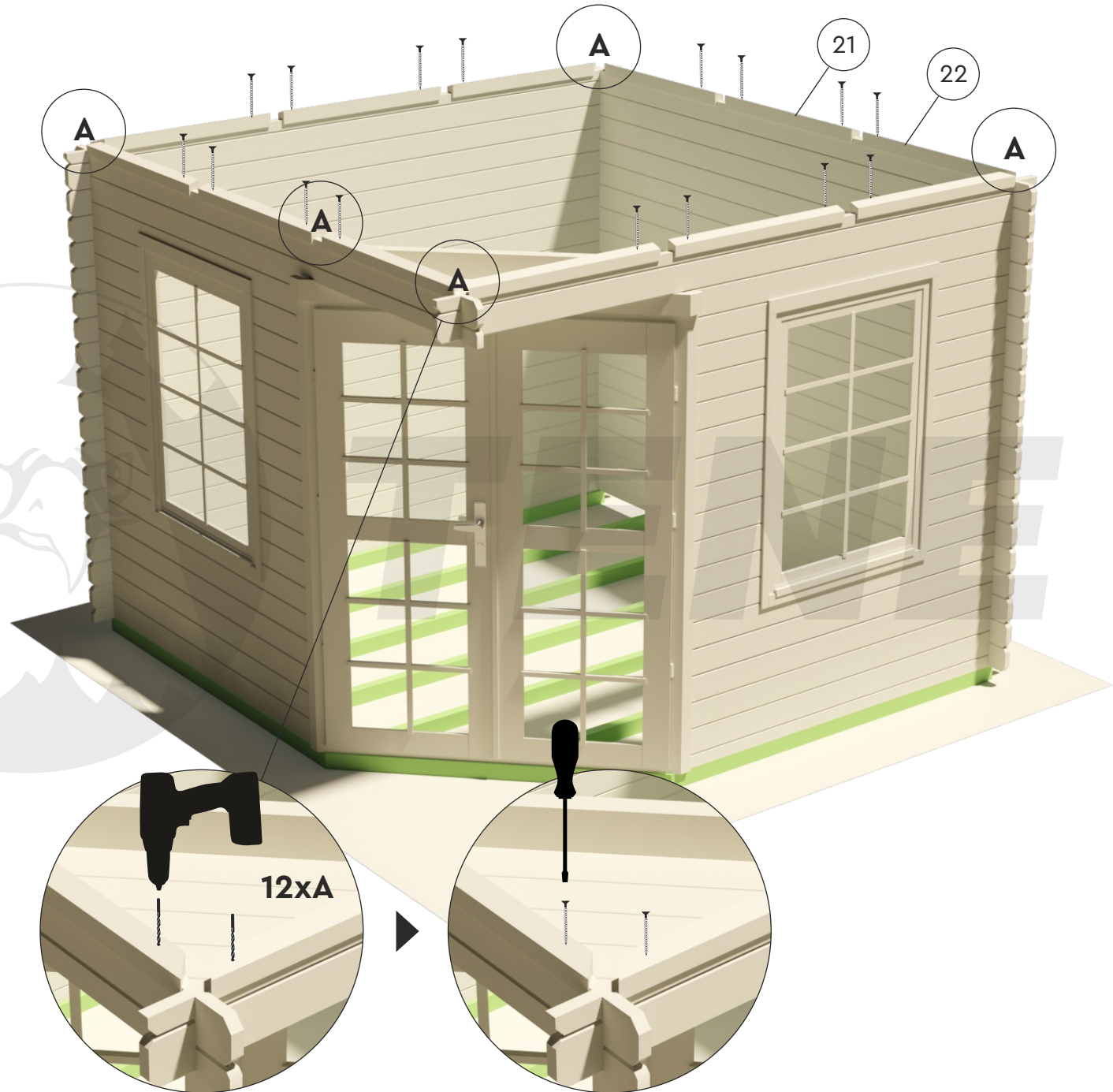

VICTORIA B 28

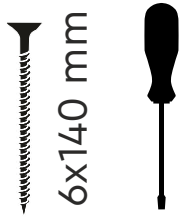
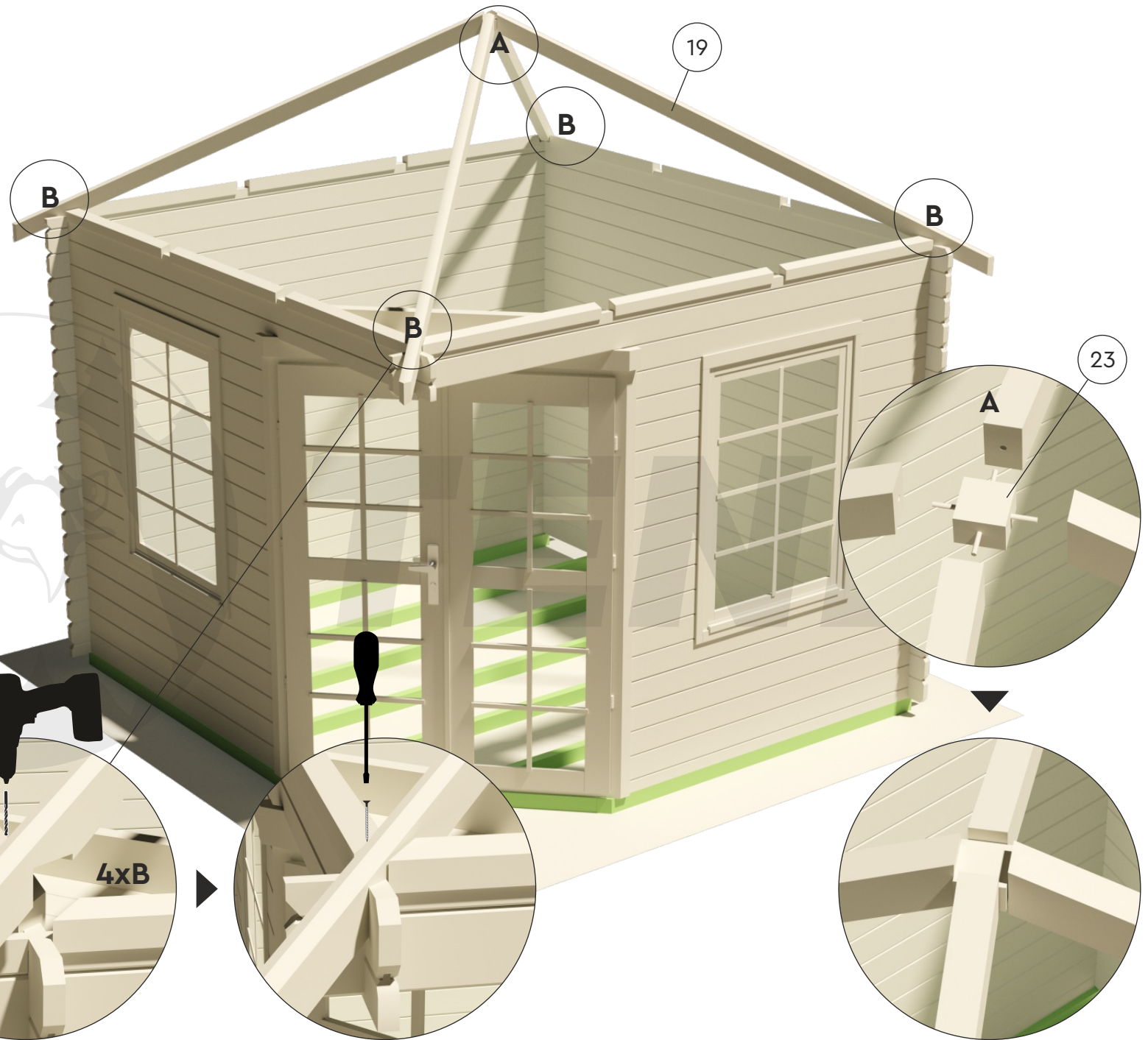

VICTORIA B 28



ø 5 mm



ø 4 mm



6x140 mm



5x70 mm

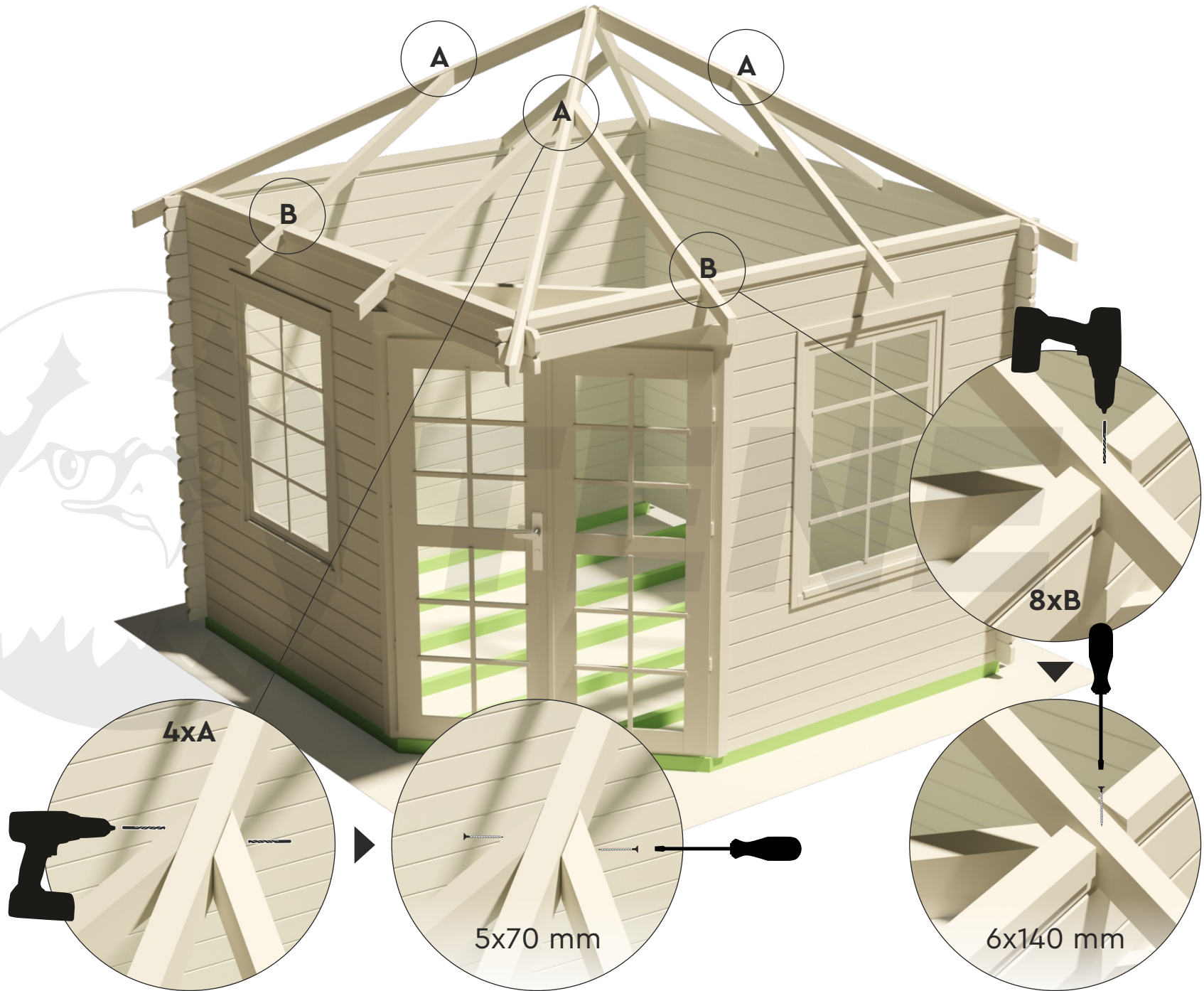

VICTORIA B 28

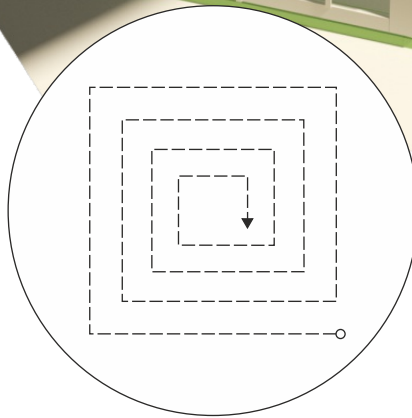
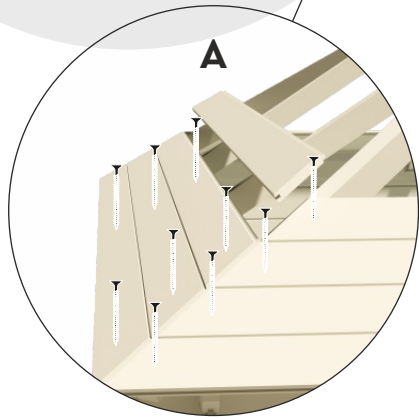
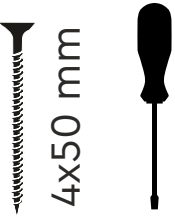
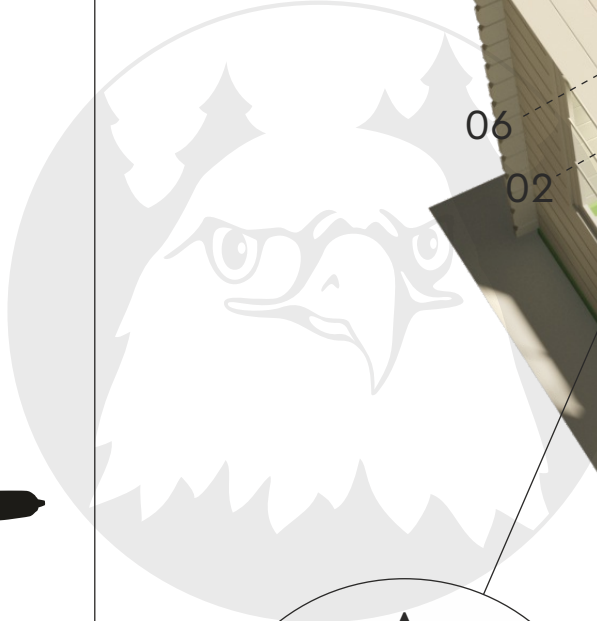
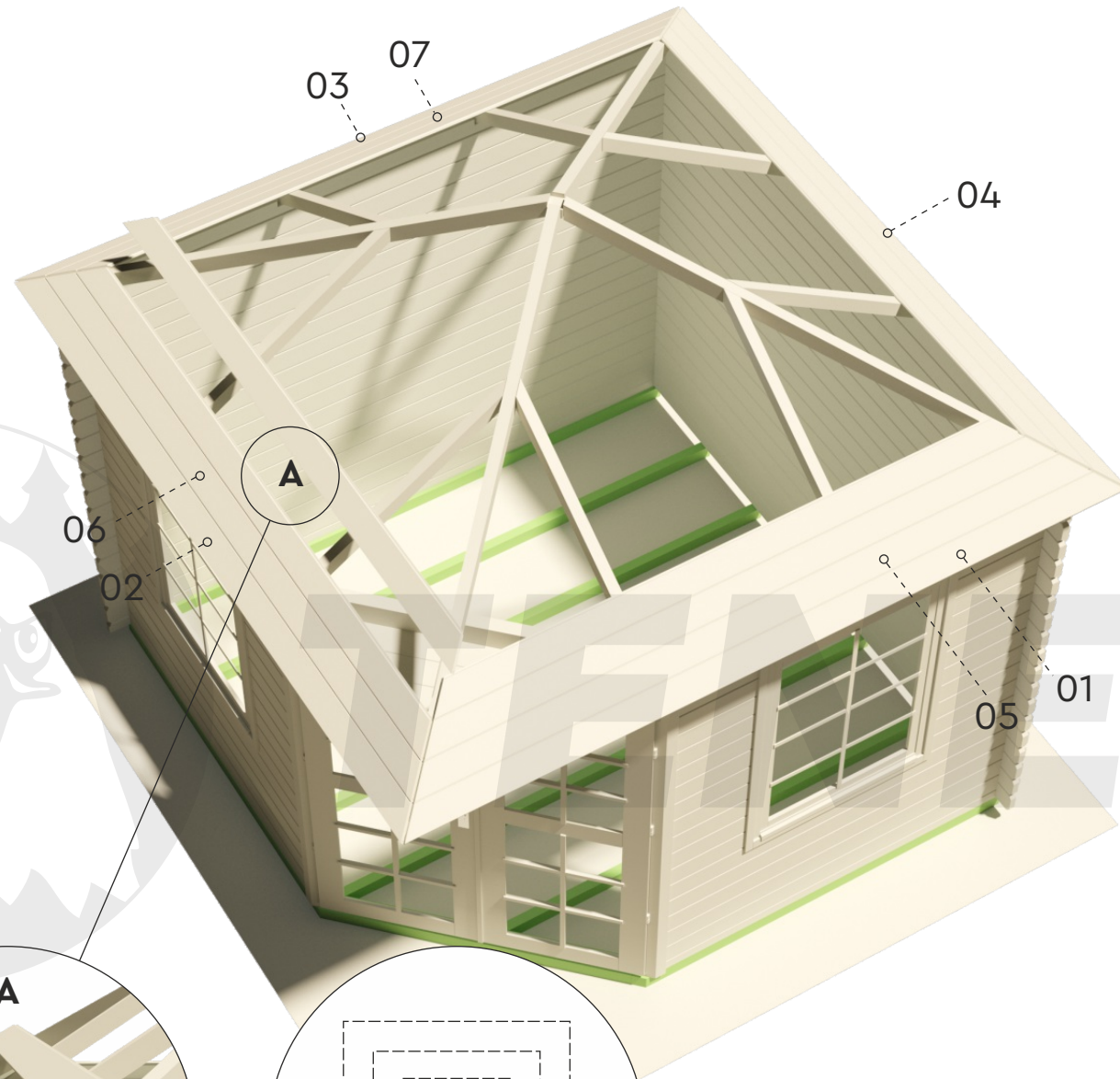

VICTORIA B 28

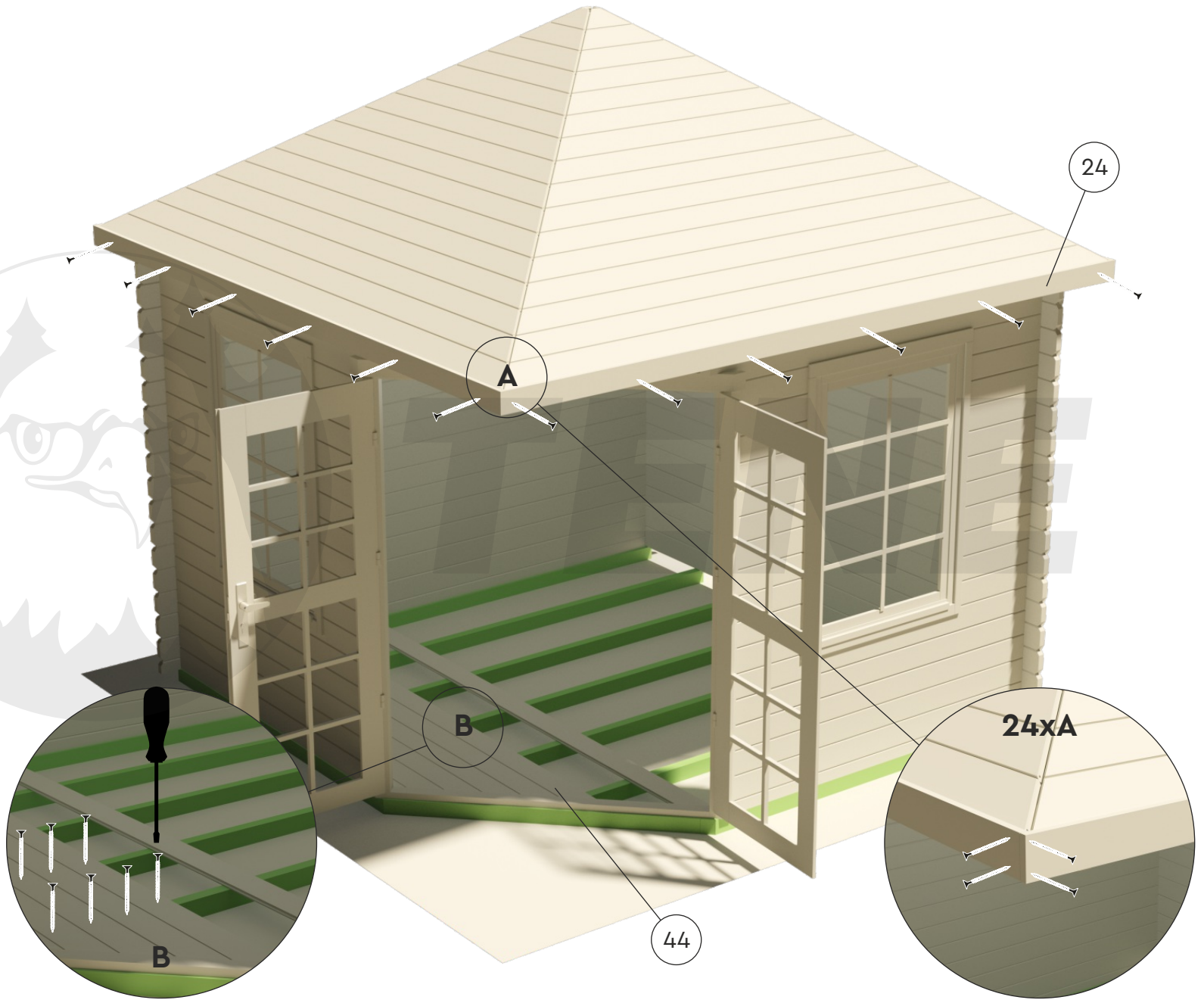
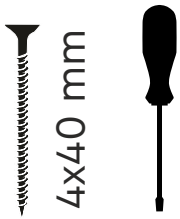

VICTORIA B 28

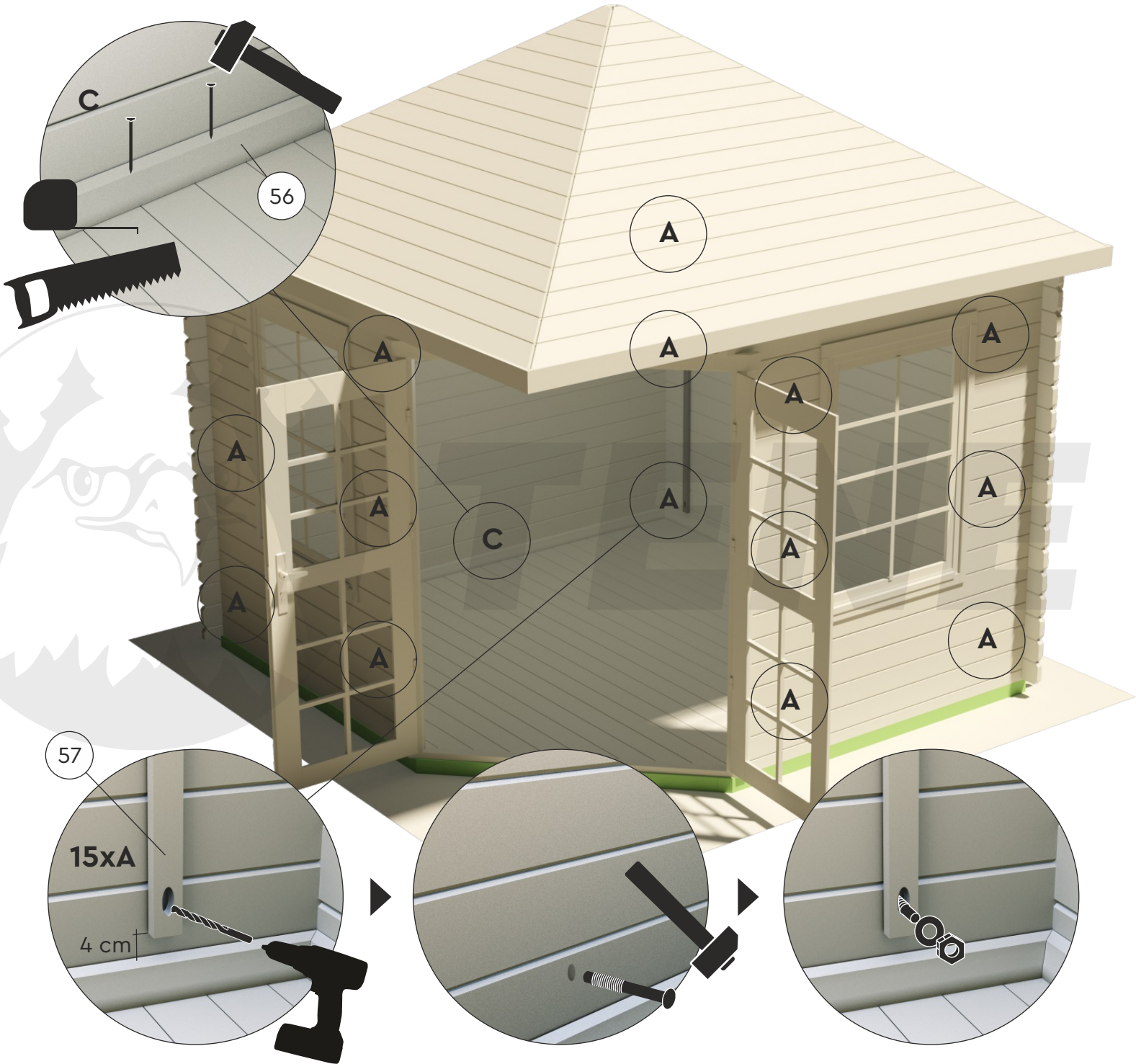

VICTORIA B 28

